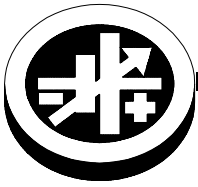
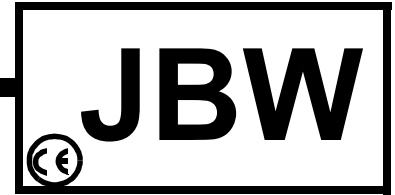


# INSTRUCTION MANUAL



**KEPCO** An ISO 9001 Company.



## 15 WATT SINGLE OUTPUT SWITCHING POWER SUPPLIES

### I — INTRODUCTION

**SCOPE OF MANUAL.** This instruction manual covers the installation and operation of the Kepco JBW 15W Series of Switching Power Supplies.

**DESCRIPTION.** The Kepco JBW 15W Series consists of four models of switching power supplies, with a single output as shown in Table 1. Units may be operated with a nominal 100V a-c to 240V a-c (input voltage range 85 to 265 Va-c), 50-60 Hz (input frequency range 47-440Hz.) They will also operate on 110V to 370V d-c input. The JBW 15W Series employs a light weight ferrite core with a variable switching frequency. Regulation is provided by pulse width modulation. A FET power stage, operating in the ringing choke converter mode provides a smooth isolated d-c output. A thermistor circuit prevents excessive turn-on current surge. Overvoltage protection is provided. Current limiting with automatic recovery from short circuit is featured. Units are manufactured on an open frame pc board.

Table 1 contains specifications and operating limits of individual JBW 15W Series models. Section II (following) contains specifications and operating limits common to all JBW 15W Series Models.

### II — SPECIFICATIONS

The following specifications are at nominal input voltages at 25°C unless otherwise specified.

**TABLE 1. OUTPUT RATINGS AND SPECIFICATIONS, JBW 15W SERIES**

MODEL	JBW 05-3R0	JBW 12-1R3	JBW 15-1R0	JBW 24-0R7	
OUTPUT VOLTS, d-c	5V	12V	15V	24V	
SETTING TOLERANCE	4.75-5.25V	11.4-12.6V	14.25-15.75V	22.8-25.2V	
ADJUSTMENT RANGE	FIXED	FIXED	FIXED	FIXED	
MAXIMUM OUTPUT RATINGS	50° C amb.	3.0A/15W	1.9A/22.8W	1.7A/25.5W	0.7A/16.8W
	60° C amb.	2.1A/10.5W	1.33A/15.96W	1.19A/17.85W	0.49A/11.76W
OUTPUT CURRENT (AMPS)	3.0	1.3	1.0	0.7	
CURRENT LIMIT (AMPS)	3.15 min	1.37 min	1.05 min	0.74 min	
OVP RANGE (VOLTS)	5.75 min	13.8 min	17.25 min	27.6 min	
EFFICIENCY	100 Va-c	72%	76%	76%	78%
	240 Va-c	72%	74%	74%	76%
OUTPUT CAPACITOR $\mu$ Fmax., (fixed load resistance)	10000	5000	4000	2000	
RIPPLE AND NOISE <sup>(1)</sup> (mV p-p)	ripple (typ)	80	120	120	120
	ripple -10-0°C, max	140	160	160	160
	spike noise (typ) <sup>(2)</sup>	120	150	150	150
	spike noise -10-0°C, max <sup>(2)</sup>	160	180	180	180

(1) 0 to 100% load, 0 to 50 °C, tested with 100 $\mu$ F electrolytic and 0.1 $\mu$ F film capacitors across the load and connected to the power supply via 5.9 in (150mm) wires  
(2) Measured with a 20 MHz bandwidth.

#### INPUT VOLTAGE:

Nominal 100-240V a-c, range: 85-265V a-c (0 to 100% load, -10 to 60°C)  
d-c range: 110 -370V d-c

#### INPUT SOURCE FREQUENCY:

Nominal 50/60 Hz; Range 47-440 Hz. (At 440 Hz the leakage current exceeds the VDE safety specification limit,)

#### INPUT CURRENT: (maximum load at 25°C with nominal output voltage):

0.36 typ., 0.43 max. (100 Va-c input, 100% load); 0.20A typ., 0.24A max. (240 Va-c input, 100% load)

**INPUT PROTECTION AND SOFT START:** A thermistor circuit reduces start-up surge. Units are protected against shorts by an input fuse. Fuse value 2.0A, 250V.

#### INPUT SURGE: cold start

15A typ, 19.5A max. (100 V a-c, 100% load); 30A typ., 41A max. (240 Va-c, 100% load)

**POWER FACTOR:** 0.6 typ. at 100 Va-c, 0.45 typ. at 240 Va-c

KEPCO, INC. ● 131-38 SANFORD AVENUE ● FLUSHING, NY. 11352 U.S.A. ● TEL (718) 461-7000 ● FAX (718) 767-1102

©2003, KEPCO, INC

<http://www.kepcopower.com> ● email: [hq@kepcopower.com](mailto:hq@kepcopower.com)

Data subject to change without notice

228-1413 REV 2

## STABILIZATION:

Source Effect (85 to 265 Va-c) 0.4% max.  
Load Effect, measured at sensing terminals (0% - 100% load change) 0.8% max.  
Temperature effect (-10 to 50°C) 1.0% max.  
Combined effect (envelope including overshoot at start up) 4.0% max.  
Drift (1/2 to 8 hr. at 25°C) 0.4% max.

**TRANSIENT RECOVERY:** A step load change from 50% to 100% of rated load in 50 microseconds or more, produces no more than 4% output voltage excursion. Temperature range from -10 to 50°C.

**OUTPUT HOLDING TIME:** Upon input interruption the output is maintained for 150 milliseconds typical with 240 Va-c input voltage, and for 13 milliseconds typical with 100 Va-c input voltage. The condition for output load is 100%.

**START UP TIME:** 200ms max., 25ms typ. at 100 Va-c, 100ms max., 25ms typ. at 240 Va-c (JBW 5V and 12V)  
200ms max., 40ms typ. at 100 Va-c, 100ms max., 40ms typ. at 240 Va-c (JBW 15V and 24V)

**OVERVOLTAGE PROTECTION:** Fixed, factory set. See Table 1. The overvoltage circuit is set by Zener diode clamp, latching could occur.

**OVERCURRENT:** Square type, output voltage returns to rated level upon removal of cause of malfunction (long term overcurrent could damage unit)

**OPERATING TEMPERATURE:** -10 to 60°C (start up -20 to 60°C). See the derating, Figure 1. Do not allow the power supply to become dust covered because that will decrease the cooling efficiency of the unit and cause insulation to deteriorate.

**STORAGE TEMPERATURE:** -30°C to +75°C.

**COOLING:** Natural convection

**ORIENTATION:** Vertical or horizontal

**HUMIDITY:** 20% to 90% relative humidity, operating and storage, noncondensing,  
wet bulb temperature < or = 35°C

## WITHSTANDING VOLTAGE:

(at 5 to 35°C ambient, 45 to 85% relative humidity, cutout current 10 ma):  
Between input and output terminals, 3.0 KV a-c for 1 minute (with Y-capacitor removed).  
Between input and output or chassis, 2000V a-c for 1 minute.  
Between input terminals and chassis, 500V a-c for 1 minute.

**INSULATION RESISTANCE:** Between input and output, input and ground, output and ground 100 megohms minimum (500V d-c, 5 to 35°C ambient, 45 to 85% relative humidity)

## LEAKAGE CURRENT:

0.75mA max, 0.2mA typ at 100V a-c and 60 Hz (single pole switching)  
0.75mA max, 0.30mA typ at 240V d-c and 60 Hz (single pole switching in conformance to UL 1950/IEC 950)

**VIBRATION:** Three axes, one hour each, sweep time 10 min., nonoperating  
5-10 Hz., 10 mm amplitude  
10-200 Hz., 2G (19.6m/s<sup>2</sup>)

**SHOCK:** Three axes, 60G (588m/s<sup>2</sup>), 11 ms ±5msec pulse duration, three shocks each axis, nonoperating, 1/2 sine pulse

**SAFETY:** All units designed to meet UL 1950-3, CSA Electrical Bulletin 22.2NO950-95, and TÜV Rheinland EN60950 (ambient temp. 50°C). JBW 15W units are CE marked per the Low Voltage Directive (LVD), EN60950. [The standards do not apply with DC input operation]

**EMI RADIATED:** FCC Class B, VCCI-B, EN55011-B, EN55022-B

**ESD:** Ground potential area, 10KV (charge capacitor 500PF, series resistor 100 ohms)

**SURGE WITHSTAND:** 1.2x50µs 3KV pulse (operating, 100 ohm internal series resistor)

**INCOMING NOISE:** 1 µs 2 KV pulse, 50-60Hz, with 50 ohm termination, input to input, input to ground, less than five minutes, operating

**WARRANTY:** One year.

## III — INSTALLATION

**CONNECTIONS:** Connect the load to the power supply by connecting the two (+) output wires from terminal block TB2 to the load (+) terminal, and the two (-) output wires from TB2 to the load (-) terminal. The AC input power is applied via the terminal block TB1. Make sure to connect the AC input Neutral and Line wires to the P2 and P3 pins respectively of TB1 (see Figure 2). A Cable Kit (P/N 219-0406) is available as an option from Kepco (see Figures 2 and 5). The kit includes an input cable, terminated on one end with an input mating connector; and an output cable, terminated on one end with an output mating connector.

**INSTALLING THE POWER SUPPLY:** Refer to Figures 3 and 4. The unit may be mounted on one mounting surface. The air surrounding the power supply must not exceed the ambient values given in the graph in Figure 1.

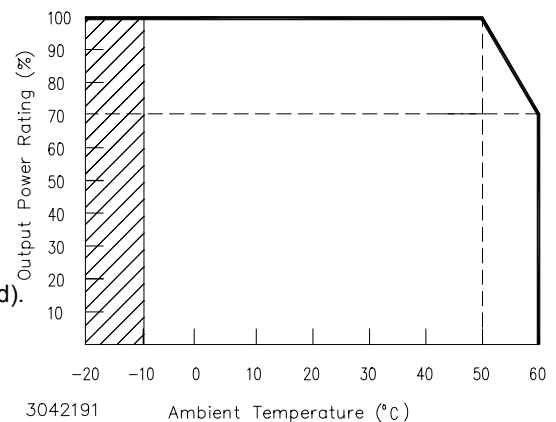


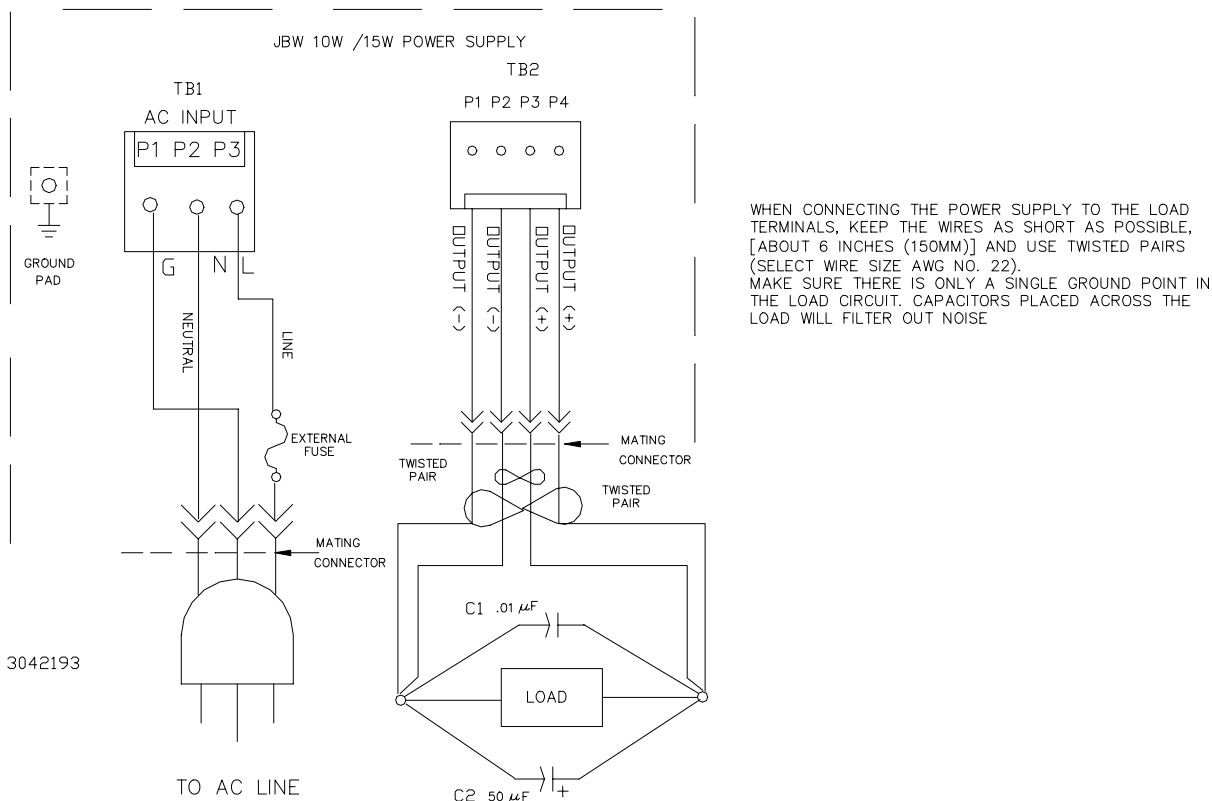
FIGURE 1. DERATING PLOT

**INSTALLATION (INSULATION):** Install unit 0.3 inches (8mm) away from base with the use of 0.24 inch (6mm) diameter spacers attached to the PC board. Keep at least 0.16 inches (4mm) spacing around and above the unit to comply with insulation and safety requirements. An insulator must be used if the spacing is less than 0.16 inches (4mm) (see Figure 3).

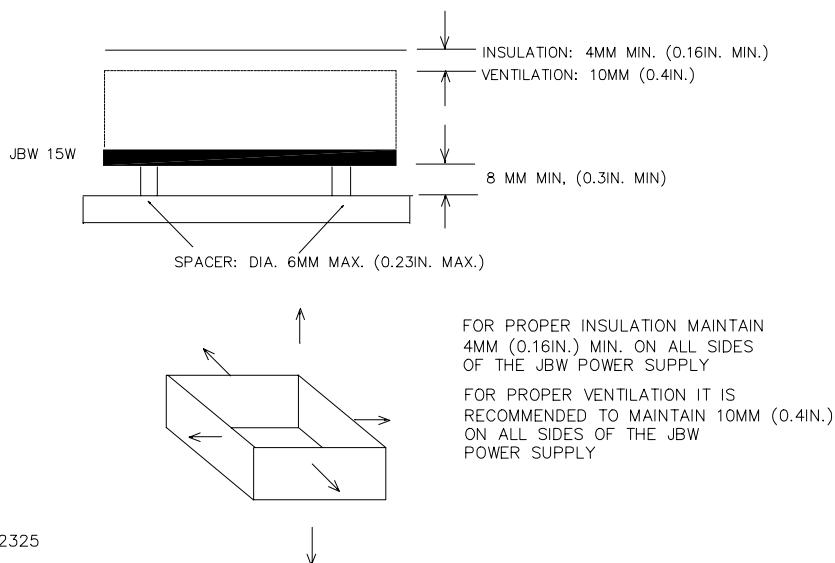
**VENTILATION:** It is recommended to keep at least 0.39 inches (10mm) clearance from adjacent equipment for proper ventilation

## IV — OPERATION

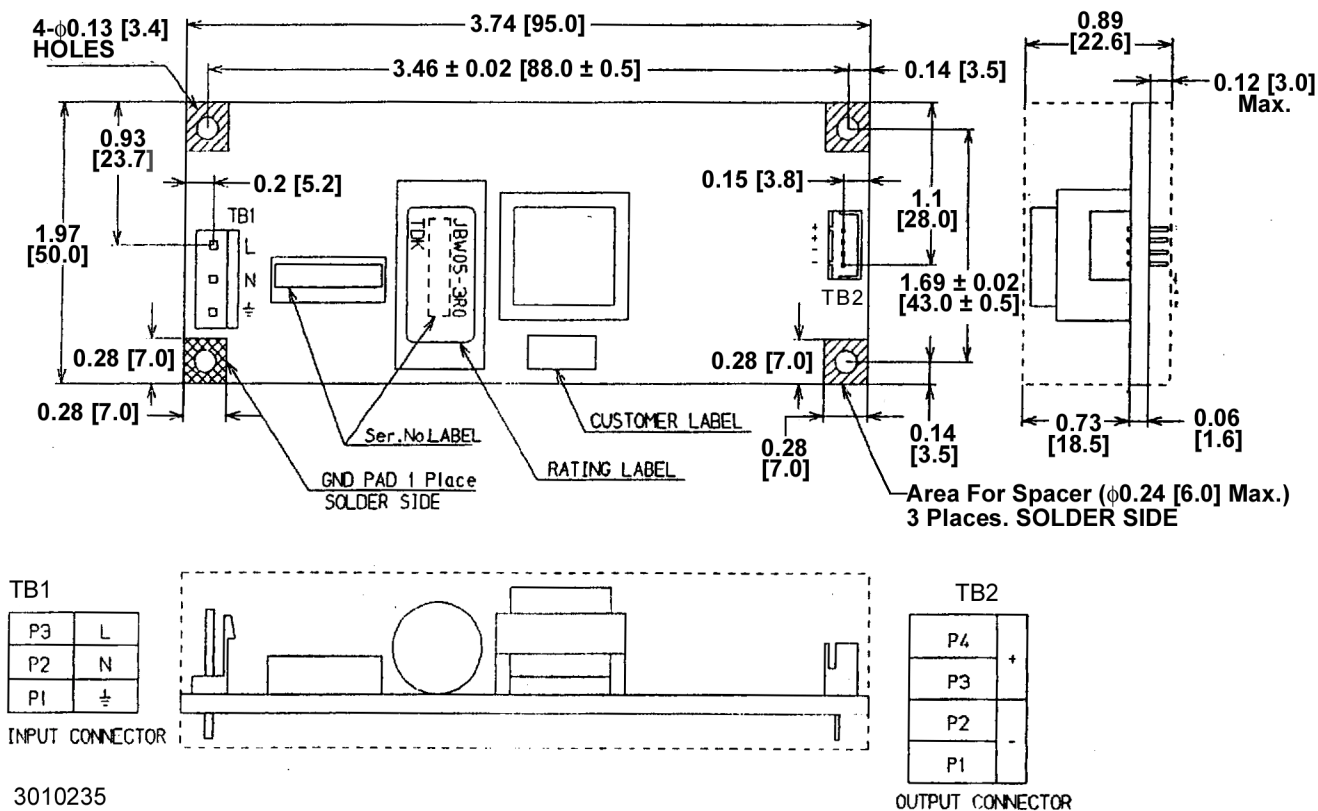
**PROTECTION DIODE:** When a number of power supplies are operating in series, the current rating is to be limited to the rating of the power supply with the lowest rating. A diode ( $V_r > 2 \sum V_o$ ,  $I_f > 2 I_o$ ,  $V_f \ll \text{low}$ ) must be connected to the power supply output terminals to protect the unit from reverse voltage.



**FIGURE 2. LOAD CONNECTIONS**

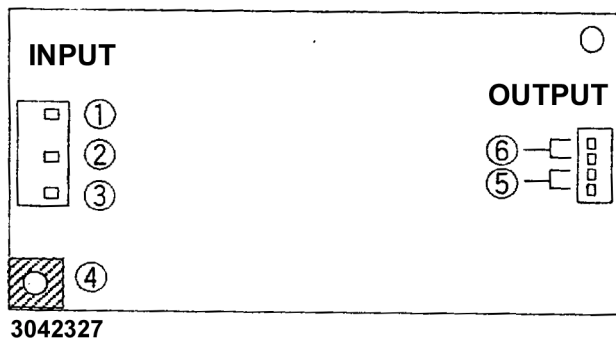


**FIGURE 3. VENTILATION AND INSULATION**



- NOTES:
1. Dimensions are in inches, brackets are in millimeters.
  2. TOLERANCES:  $\pm 0.04$ " [ $\pm 1.0$  mm] unless specified.
  3. WEIGHT: 2.82oz. ( 80 gr.) max.
  4. PCB: Thickness =  $0.06 \pm 0.008$  in. ( $1.6 \pm 0.2$ mm)

FIGURE 4. JBW 15W MECHANICAL OUTLINE DIAGRAM



Terminal	Function
1	Input L
2	Input N
3	Ground
4	Ground Pad
5	Output (-)
6	Output (+)

Mating Connectors <sup>(3)</sup>			
Connector	Terminal Pin	Socket Housing	MFR
Input	SVH-21T-P1.1	VHR-5N	JST <sup>(1)</sup>
	T101	H101-05	LCE <sup>(2)</sup>
Output	SXH-001T-P0.6	XHP-4	JST <sup>(1)</sup>
	T221-01	H221-04	LCE <sup>(2)</sup>

(1) JST= Japan Solderless Terminal Mfg. Co.

(2) LCE= Long Chu Electronics Co.

(3) Optional cable kit (P/N 219-0406) includes one input and one output cable (one meter long) with mating connectors for TB1 and TB2, unterminated at other end.

FIGURE 5. INPUT/OUTPUT CONNECTIONS